

350



# ADW3 1 0 Wireless Meter

Installation and Instruction Manual V 1. 0

Acrel Co., Ltd.

# **declare**

All rights reserved. Without the written permission of the company, any paragraphs and chapters in this manual shall not be excerpted, copied or reproduced or transmitted in any form , otherwise all consequences shall be borne by the offender.

The company reserves all legal rights.

The company reserves the right to modify the product specifications described in the manual without prior notice. Before ordering, please consult your local distributor for current specifications of this product.

Manual revision record

<b>date</b>	<b>old version</b>	<b>new version</b>	<b>Remark</b>
202 2/8/8 _ ---		V1.0	1. The first edition of the manual;



## Table of contents

1 Overview .....	5
2 Product model specifications and functional characteristics .....	6
2.1 ADW310 wireless meter naming rules .....	6
2.2 ADW310 wireless measuring instrument features	6

### 1 Overview

ADW310 wireless measuring instrument is mainly used to measure the active energy of low-voltage network. It has the advantages of small size, high precision, rich functions, etc., and has many optional communication methods, which can support RS485 communication and Lora, 4G and other wireless communication methods , increasing the The current sampling mode of the external transformer is convenient for users to install and use in different occasions . It can be flexibly installed in the distribution box to meet the needs of power metering, operation and maintenance supervision or power monitoring for different areas and different loads .

## 2 Product model specifications and functional characteristics

### 2.1 ADW310 wireless meter naming rules

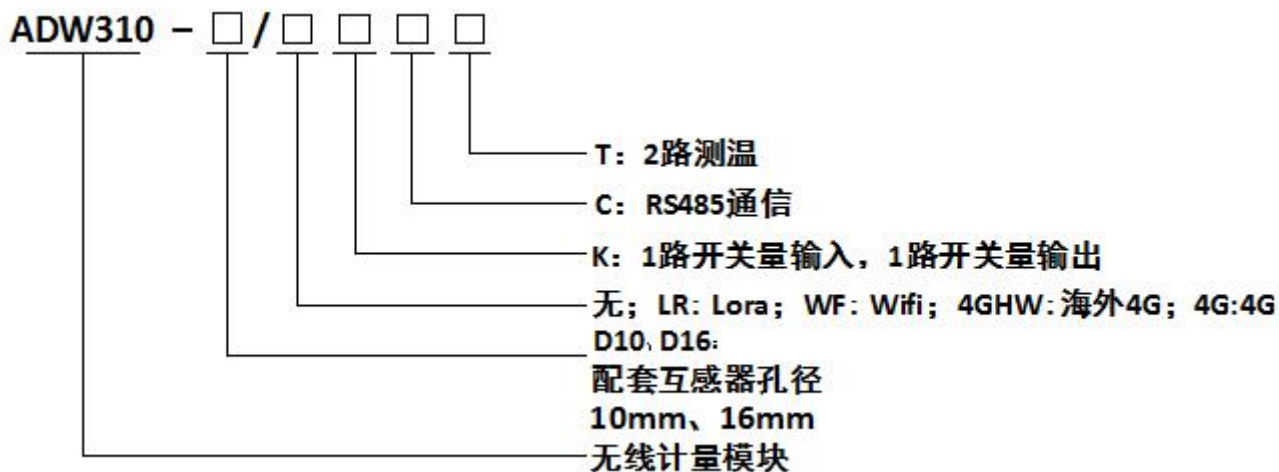

### of ADW310 Wireless Metering Instrument

Table 1 ADW3 1 0 main functions

Function	Function Description
Display method	LCD (field type)
Energy metering	Active energy metering (forward, reverse),
Electricity measurement	Voltage, current, power factor, frequency, active power, reactive power, apparent power
Harmonic function	Total harmonic content, sub-harmonic content (2 to 31 times)
Pulse output	Active pulse output
Temperature measurement function	Two- way temperature measurement (optional T)
DI/DO	1 DI, 1 DO (optional K)
LED indication	Pulse light indication
External transformer	External open type transformer
Electric parameter alarm	Undervoltage, overvoltage, undercurrent, overcurrent, underload, overload, etc.
communication	RS485 interface (optional C)
	470MHz wireless transmission (optional LR)
	4G wireless transmission (optional 4G)
	WIFI wireless communication (optional WF)

### 3 Technical parameters

#### 3.1 Electrical Characteristics

Table 2 ADW3 1 0 electrical characteristics

Voltage input	Rated voltage	220V
	reference frequency	50Hz
	Power consumption	<0.5VA per phase
Current input	Input Current	AC 20(100)A
	Starting current	1‰lb (grade 0.5S), 4‰lb (grade 1)
	Power consumption	<1VA per phase
Auxiliary power	Supply voltage	AC 85~265V
	Power consumption	< 2W
Measuring performance	Standards compliant	GB/ T17215.322-200 8 , GB / T17215.321-200 8
	Active energy accuracy	Level 1
	temperature accuracy	±2℃
pulse	Pulse Width	80±20ms
	Pulse constant	1600 imp/kWh
communication	wireless	470MHz wireless transmission, transmission distance in open space: 1km; 4G
	interface	RS485 (A, B)
	medium	shielded twisted pair
	protocol	MODBUS-RTU, DL/T 645-07

#### 3.2 Environmental conditions

Table 3 ADW3 1 0 Environmental Conditions

temperature range	Operating temperature	-2 5 ℃ ~ 55 ℃
	storage temperature	- 40 ℃ ~ 70 ℃
humidity		≤95% (no condensation)
altitude		<2000m

## 4 Dimensions and installation instructions (unit: mm)

### 4.1 Dimensions (unit: mm)

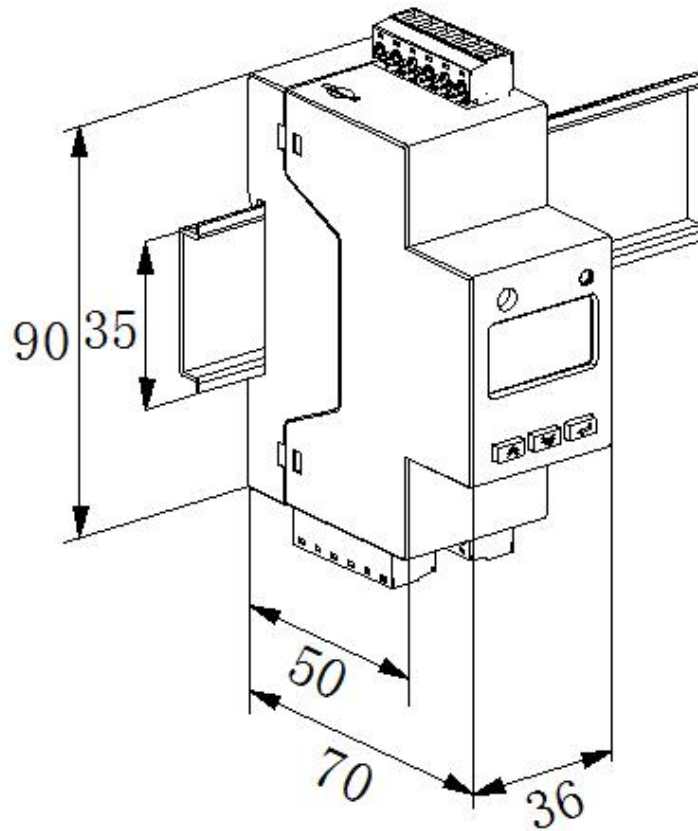
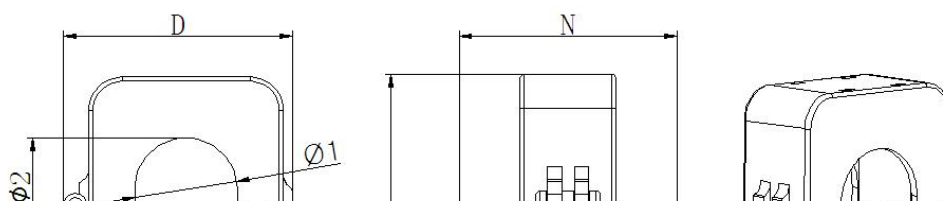

Figure 1 ADW3 1 0 effect size chart

### (2) Dimensions of supporting transformers

Table 5 Specifications and Dimensions of Supporting Transformers

Specification	Dimensions (mm)					Perforation size (mm)		Tolerance (mm)
	W	H	D	M	N	Φ1	Φ2	
AKH-0.66/K-∅ 10N	27	44	32	25	36	10	9	±1
AKH-0.66/K-∅ 16N	31	50	36	27	42	16	17	





### Matching transformer size chart

#### 4.2 RS485 communication terminal, pulse output terminal

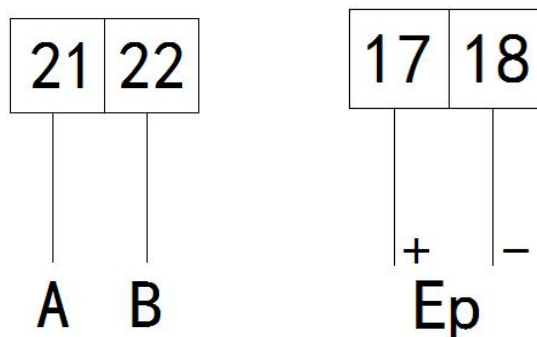

Communication interface pulse port

#### 4.3 Switch input/output terminals

The switch input is the switch signal input method, the instrument is equipped with +12V working power supply, no external power supply is required. When the external connection is turned on or off, the on or off information is collected through the instrument switch input module and displayed locally by the instrument. The switch input can not only collect and display the local switch information, but also realize the remote transmission function through the RS485 of the instrument, that is, the "remote signal" function.

Switch output is relay output, which can realize "remote control" and alarm output.

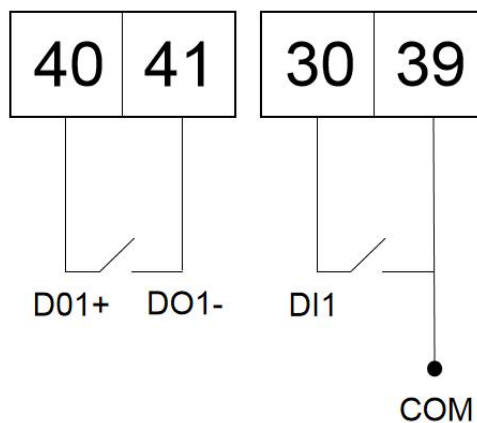

Switch input and output

#### 4.4 Temperature measuring terminal

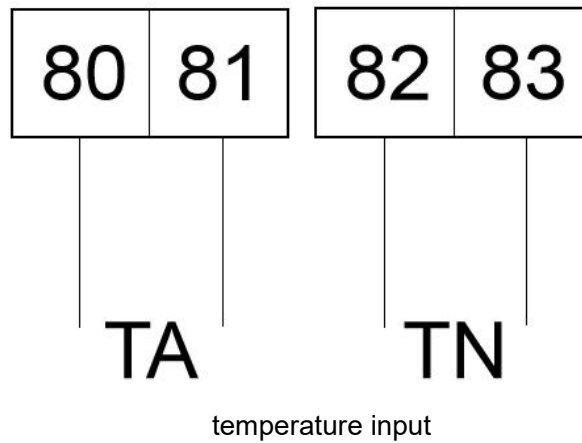

#### 4.5 Wiring Instructions

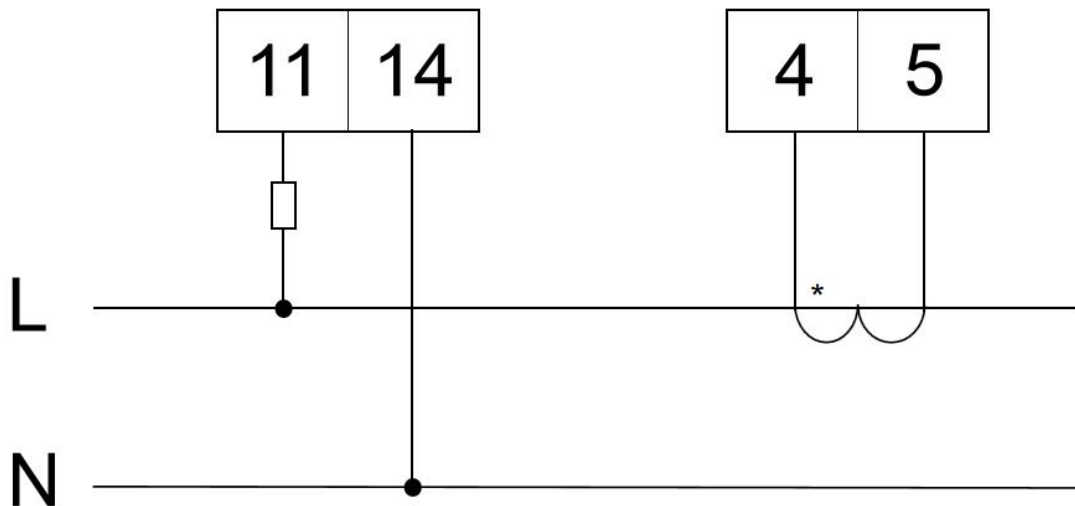

### 5 Main Features

#### 5.1 Measurement function

It can measure all power parameters including voltage U, current I, active power P, reactive power Q, apparent power S, power factor PF, phase angle  $\Phi$  between voltage and current, frequency F, 31st harmonic, parity Total harmonic content and total harmonic content. Among them, the voltage U has 1 decimal place, the frequency F has 2 decimal places, the current I has 3 decimal places, the power P has 4 decimal places, and the phase angle  $\Phi$  has 2 decimal places.

Such as:  $U = 220.1V$ ,  $f = 49.98HZ$ ,  $I = 1.999A$ ,  $P = 0.2199KW$ ,  $\Phi = 60.00^\circ$ .

Support 2 -way temperature measurement, temperature measurement range:  $-40 \sim 99^\circ C$ , accuracy  $\pm 2^\circ C$

## 5.2 Metering function

It can measure the current combined active energy, forward active energy, reverse active energy, inductive reactive energy, capacitive reactive energy, and apparent energy.

## 5.3 Time-sharing function

Two sets of timetables, one year can be divided into 4 time zones, each set of timetables can set 12 daily time periods, 4 rates (F1, F2, F3, F4 are peaks and valleys). The basic idea of time-of-use billing is to use electric energy as a commodity, using economic leverage, the electricity price is high during the peak period of electricity consumption, and the electricity price is low when the valley is low, so as to cut the peak and fill the valley, improve the quality of electricity consumption, and improve the overall economic benefits.

## 5.4 Demand function

The concepts related to demand are as follows:

demand	The average power measured during the demand period is called demand
maximum demand	The maximum demand in a specified time zone is called the maximum demand
slip time	From any moment, the method of recursively measuring demand according to the time less than the demand period, the measured demand is called slip demand. The recursion time is called slip time
demand cycle	Continuous measurement of average power at equal time intervals, also called window time

The default demand period is 15 minutes and the slip time is 1 minute.

It can measure 8 kinds of maximum demands, namely A/B/C three-phase current, forward active power, reverse active power, inductive reactive power, capacitive reactive power, apparent power maximum demand and the time when the maximum demand occurs.

Displays 8 real-time demands, namely A/B/C three-phase current, forward active power, reverse active power, inductive reactive power, capacitive reactive power, and apparent power demand.

## 5.5 Historical energy statistics function

It can count the historical electric energy in December (including 4 quadrants and electric energy at various rates)

## 5.6 Switch input and output functions

There are 1 switch output and 1 switch input. The switch output is relay output, which can realize "remote control" and alarm output. The switch input can not only collect and display the local switch information, but also realize the remote transmission function through the RS485 of the instrument, that is, the "remote signal"

function.

## 5.7 Wireless communication function

ADW3 1 0 supports 470MHz LORA communication and 4G communication. The specific agreement on 4G communication can be obtained by contacting the relevant personnel of our company.

## 6 Communication description

### 6.1 Communication Protocol

This instrument adopts MODBUS-RTU protocol or DL/T645 protocol. For the specific protocol format, please refer to the relevant protocol standards, which will not be repeated here.

### 6.2 MODBUS communication

When using Modbus protocol for communication, the function code of the read data command is 03H, and the function code of the write data command is 10H.

The specific register address table is as follows:

initial address (hexadecimal)	data item name	length (bytes)	read/ write	Remark
1 000H	contact address	2	R/W	1~247
1 001H	baud rate	2	R/W	1: 1200bps 2: 2 400bps 3: 4800bps 4: 9600bps 5 : 192 00bps 6 : 384 00bps
1002H	Check Digit 1	2	R/W	low byte 0: no verification 1: odd parity 2: Even parity high byte 0:1 stop bit 1: 1.5 stop bit 2:2 stop bit
1003H-1005H	reserved			
1006H	645 address	6	R/W	BCD code high order first
1009H	serial number	14	R/W	14 ASCII codes
1010H	wire system	2	R/W	0:3P4L 1:3P3L
1011H	Voltage secondary rating	2	R/W	One decimal place V
1012H	Current secondary rating	2	R/W	two decimal places A
1013H-101CH	reserved			
101DH	password	2	R/W	1-9999
101EH	Pulse constant	2	R/W	Default 1600

101FH	Voltage shield	2	R/W	0~655.35%
1020H	Current shield	2	R/W	0~655.35%
1021H-1025H	reserved			
1026H	demand cycle	2	R/W	Unit min (1-30)
1027H-102DH	reserved			
102EH	Backlight time	2	R/W	0: always on 1: 1min 2:2min
102FH	time	10	R/W	Year, Month Day, week, hour, minutes, seconds, millisecond
1034H-1035H	reserved			
1036H	DO status	2	R/W	Bit0: DO1 Bit1: DO2... 0: open 1: closed
1037H	DI status	2	R	Bit0:DI1 Bit1:DI2... 0: open 1: closed
1038H	<p>First time zone timetable number first time zone start month, first time zone day</p> <p>Second time zone timetable number Second time zone start month, second time zone day</p> <p>Third time zone timetable number 3rd time zone start month, 3rd time zone day</p> <p>Fourth time zone timetable number 4th time zone start month, 4th time zone day</p> <p>Fifth time zone timetable number Fifth time zone start month, fifth time zone day</p> <p>Sixth time zone timetable number 6th time zone start month, 6th time zone day</p> <p>Seventh time zone timetable number 7th time zone start month, 7th time zone day</p> <p>Eighth time zone timetable number Eighth time zone start month, eighth time zone day</p>	12	R/W	<p>Time slot number: period 1, period 2, period 3, period 4, Start month: 1-12 Start day: 1-31</p>
1044H	The first set of timetables, Each period occupies three bytes,		R/W	Rate: 0 1 point, 2 peaks

	Rate, start time, start minute respectively			3 flats, 4 valleys Start: 0-23 Start Score: 1-59
1059H	The second set of timetables, Each period occupies three bytes, Rate, start time, start minute respectively		R/W	Same as the first set of timetables
106EH	The third set of timetables, Each period occupies three bytes, Rate, start time, start minute respectively		R/W	Same as the first set of timetables
1083H	The fourth set of timetables, Each period occupies three bytes, Rate, start time, start minute respectively		R/W	Same as the first set of timetables
1098H	Voltage ratio	4	R/W	plastic
109AH	Current transformation ratio	4	R/W	plastic
109CH-109FH	reserved			

2000H	Voltage	4	R	Integer Keep 1 decimal place, the unit is V If the value is $U = 2200$ , $PT = 1$ ; $U = U * P * T = 2200 * 0.1 * 1 = 220.0$ V
2001H-200BH	reserved			
200CH	current	4	R	Integer, unit A 2 decimal places If the value is $I = 200$ , $CT = 10$ ; $I = I * CT = 200 * 0.01 * 10 = 20$ A
200DH-2013H	reserved			
2014H	Active power	4	R	Integer signed Unit kW 3 decimal places If the value is 11720, $P = 10$ , $CT = 10$ ; Then value = value * $P * T * CT = 11720 * 0.001 * 10 * 10 = 1172.0$ kW
2016H-201BH	reserved			
201CH	reactive power	4	R	Integer signed

				Unit kVar 3 decimal places Analyze the same active power
201EH-2023H	reserved			
2024H	inspecting power	4	R	Integer Unit KVA 3 decimal places Analyze the same active power
2026H-202BH	reserved			
202CH	power factor	4	R	Integer 3 decimal places If the value is 999, Then the value= $999*0.001=0.999$
202EH-2033H	reserved			
2034H	frequency	4	R	Integer 2 decimal places If the value is 5000 , Then the value = $5000*0.01= 50.00H$
2036H-	reserved			
2058H	temperature 1	4	R	Integer signed Unit 0.1°C
205AH	temperature 2	4	R	Integer signed Unit 0.1°C

3000H	Secondary value of total active energy	4	R/W	Two decimal places, Kwh
3002H	Secondary value of forward active energy	4	R/W	Two decimal places, Kwh
3004H	Secondary value of reverse active energy	4	R/W	Two decimal places, Kwh
3006H	Secondary value of total reactive energy	4	R/W	Two decimal places, Kvarh
3008H	Secondary value of forward reactive energy	4	R/W	Two decimal places, Kvarh
300AH	Secondary value of reverse reactive energy	4	R/W	Two decimal places, Kvarh
300CH	reserved			
300EH	Total active energy peak secondary value	4	R/W	Integer, unit kWh 2 decimal places If the value is 120201, P T=10 , CT=10; Then value = value * P T*CT= $120201*0.01*10*10=12020$
3010H	Total active energy peak secondary	4	R/W	Integer, unit kWh

	value			<p>2 decimal places</p> <p>If the value is 120201, P</p> <p>T=10 , CT=10;</p> <p>Then value = value * P</p> <p>T*CT=</p> <p>120201*0.01*10*10=12020</p>
3012H	Total active energy level quadratic value	4	R/W	<p>Integer, unit kWh</p> <p>2 decimal places</p> <p>If the value is 120201, P</p> <p>T=10 , CT=10;</p> <p>Then value = value * P</p> <p>T*CT=</p> <p>120201*0.01*10*10=12020</p>
3014H	Secondary value of total active energy valley	4	R/W	<p>Integer, unit kWh</p> <p>2 decimal places</p> <p>If the value is 120201, P</p> <p>T=10 , CT=10;</p> <p>Then value = value * P</p> <p>T*CT=</p> <p>120201*0.01*10*10=12020</p>
3016H	Forward active energy peak secondary value	4	R/W	<p>Integer, unit kWh</p> <p>2 decimal places</p> <p>If the value is 120201, P</p> <p>T=10 , CT=10;</p> <p>Then value = value * P</p> <p>T*CT=</p> <p>120201*0.01*10*10=12020</p>
3018H	Forward active energy peak secondary value	4	R/W	<p>Integer, unit kWh</p> <p>2 decimal places</p> <p>If the value is 120201, P</p> <p>T=10 , CT=10;</p> <p>Then value = value * P</p> <p>T*CT=</p> <p>120201*0.01*10*10=12020</p>
301AH	Forward active energy level quadratic value	4	R/W	<p>Integer, unit kWh</p> <p>2 decimal places</p> <p>If the value is 120201, P</p> <p>T=10 , CT=10;</p> <p>Then value = value * P</p> <p>T*CT=</p> <p>120201*0.01*10*10=12020</p>
301CH	Forward active energy valley secondary value	4	R/W	<p>Integer, unit kWh</p> <p>2 decimal places</p> <p>If the value is 120201, P</p> <p>T=10 , CT=10;</p> <p>Then value = value * P</p> <p>T*CT=</p>



				120201*0.01*10*10=12020
301EH	Reverse active energy peak secondary value	4	R/W	Integer, unit kWh 2 decimal places If the value is 120201, P T=10 , CT=10; Then value = value * P T*CT= 120201*0.01*10*10=12020
3020H	Reverse active energy peak secondary value	4	R/W	Integer, unit kWh 2 decimal places If the value is 120201, P T=10 , CT=10; Then value = value * P T*CT= 120201*0.01*10*10=12020
3022H	Reverse active energy valley secondary value	4	R/W	Integer, unit kWh 2 decimal places If the value is 120201, P T=10 , CT=10; Then value = value * P T*CT= 120201*0.01*10*10=12020
3024H	Forward reactive energy peak secondary value	4	R/W	Integer, unit kWh 2 decimal places If the value is 120201, P T=10 , CT=10; Then value = value * P T*CT= 120201*0.01*10*10=12020
3026H	Forward reactive energy peak secondary value	4	R/W	Integer, unit kWh 2 decimal places If the value is 120201, P T=10 , CT=10; Then value = value * P T*CT= 120201*0.01*10*10=12020
3028H	Secondary value of forward reactive energy level	4	R/W	Integer, unit kWh 2 decimal places If the value is 120201, P T=10 , CT=10; Then value = value * P T*CT= 120201*0.01*10*10=12020
302AH	Forward reactive energy valley secondary value	4	R/W	Integer, unit kWh 2 decimal places If the value is 120201, P T=10 , CT=10;

				Then value = value * P T*CT= 120201*0.01*10*10=12020
302CH	Reverse reactive energy peak secondary value Reverse reactive energy peak secondary value	4	R/W	Integer, unit kWh 2 decimal places If the value is 120201, P T=10 , CT=10; Then value = value * P T*CT= 120201*0.01*10*10=12020
302EH	Reverse reactive energy level secondary value	4	R/W	Integer, unit kWh 2 decimal places If the value is 120201, P T=10 , CT=10; Then value = value * P T*CT= 120201*0.01*10*10=12020
3030H	Reverse reactive energy valley secondary value	4	R/W	Integer, unit kWh 2 decimal places If the value is 120201, P T=10 , CT=10; Then value = value * P T*CT= 120201*0.01*10*10=12020
3032H-	reserved			

4006H	Total active power real-time demand	4	R	Integer, unit kW 3 decimal places
400CH	Total forward active power real-time demand	4	R	Integer, unit kW 3 decimal places
400EH	Total reverse active power real-time demand	4	R	Integer, unit kW 3 decimal places
4010H	Total forward reactive power real-time demand	4	R	Integer, unit kW 3 decimal places
4012H	Total reverse reactive power real-time demand	4	R	Integer, unit kW 3 decimal places
4014H-	reserved			

01D0H-01EBH	Alarm 1 related data, see chapter 6.3.1 for details
0216H-0249H	Alarm 2, alarm 3 related data, see chapter 6.3.2 for details
0268H-0169H	Alarm 2, Alarm 3 alarm status, see chapter 6.3.2 for details

## 6.3 Alarm function related settings

### 6.3.1 Alarm 1 related parameter register address table

start address (hexadecimal)	initial address (decimal)	data item name	length (bytes)	read/write	Remark
01EBH	491	Alarm 1 state	2	R	bit0: Over voltage alarm bit1: under voltage alarm Bit2: Overcurrent alarm Bit3: undercurrent alarm Bit4: Over power alarm Bit5: Under power alarm Bit6: Whether DO1 alarm output bit7: Whether DO2 alarm output Bit8: Bit9: Bit10: Bit11: Bit12: Bit13: Bit14: Bit15 : Power off report
01DOH	464	Alarm 1 enable bit	2	R/W	Bit0: Overvoltage alarm enable bit Bit1: Undervoltage alarm enable bit Bit2: Overcurrent alarm enable bit Bit3: Undercurrent alarm enable bit Bit4: Over power alarm enable bit Bit5: Under-power alarm enable bit Bit6: Whether DO1 alarm output bit7: Whether DO2 alarm output Bit8: Bit9: Bit10: Bit11: Bit12: Bit13: Bit14: Bit15 : Power- off report enable bit

01D1H _	465	Over voltage alarm threshold	2	R/W	Integer Unit 0.1V
01D2H _	466	Over voltage alarm delay	2	R/W	Integer Unit 0.01S
01D3H _	467	Undervoltage alarm threshold	2	R/W	Integer Unit 0.1V
01D4H _	468	Undervoltage alarm delay	2	R/W	Integer Unit 0.01S
01D5H _	469	Overcurrent Alarm Threshold	2	R/W	Integer Unit 0.01A
01D6H _	470	Overcurrent Alarm Delay	2	R/W	Integer Unit 0.01S
01D7H _	471	Undercurrent alarm threshold	2	R/W	Integer Unit 0.01A
01D8H _	472	Undercurrent alarm delay	2	R/W	Integer Unit 0.01S
01D9H _	473	Over power alarm threshold	2	R/W	Integer Unit 0.001kw
01DA H	474	Over power alarm delay	2	R/W	Integer Unit 0.01S
01DB H	475	Under power alarm threshold	2	R/W	Integer Unit 0.001kw
01DC H	476	Under power alarm delay	2	R/W	Integer Unit 0.01S
01DD H	477	DI1 initial state	2	R/W	0: Normally open 1: Normally closed
01DE H	478	DI1 programming	2	R/W	0: Do not associate with DO 1: Associate DO1 2: Associate DO2
01E5H _	485	DO1 output mode	2	R/W	0: level 1: Pulse
01E6H _	486	DO1 related content	2	R/W	0: Normal DO 1: total failure 2: Total fault +DI1+DI2 3: DI1 4:DI2 5:DI1+DI2
01E7H _	487	DO1 output pulse width	2	R/W	0: none 1:1S 2:2S 3:3S 4:4S 5:5S

### 6.3.2 \_ \_ Alarm 2, Alarm 3 related parameter register address table

start address (hexadecimal)	initial address (decimal)	data item name	length (bytes)	read/write	Remark
0216H	534	Alarm 2 enable bit	2	R/W	Bit0: Low power factor alarm enable bit Bit1: Bit2: Bit3: Bit4: The first channel over temperature alarm enable bit Bit5: Bit6: Bit7: The second channel over temperature alarm enable bit Bit8: Bit9: Bit10 : Bit11: Bit12: Bit13: Bit14: Bit15 :
0268H	616	Alarm 2 Alarm status	2	R	Corresponding to alarm 2 enable bit
0217H	535	Alarm 3 enable bit	2	R/W	Bit0: Current positive active power demand is too high alarm enable bit Bit1: Current reverse active power demand high alarm enable bit Bit2: Current high reactive power demand alarm enable bit Bit3: Current reverse reactive power demand high alarm enable bit Bit4: Current apparent demand high alarm enable bit

					Bit5 -Bit15: Reserved
0269H	617	Alarm 3 alarm status	2	R	Corresponding to alarm 3 enable bit
0218H	536	High power factor alarm threshold	2	R/W	Integer Unit 0.0 01
0219H	537	Power factor high alarm delay	2	R/W	Integer Unit 0.01S
0220H	544	The first circuit temperature is too high alarm threshold	2	R/W	Integer signed Unit 0.1℃
0221H	545	The first circuit over temperature alarm delay	2	R/W	Integer Unit 0.01S
0222H	550	The second circuit temperature is too high alarm threshold	2	R/W	Integer signed Unit 0.1℃
0223H	551	The second circuit over temperature alarm delay	2	R/W	Integer Unit 0.01S
0237H	567	Current unbalance too high alarm delay	2	R/W	Integer Unit 0.01S
0238H	568	The current forward active power demand is too high alarm threshold	4	R/W	Integer, unit kW 3 decimal places
023AH	570	Current reverse active power demand is too high alarm delay	2	R/W	Integer Unit 0.01S
023BH	571	The current forward active power demand is too high alarm threshold	4	R/W	Integer, unit kW 3 decimal places
023DH	573	Current reverse active power demand is too high alarm delay	2	R/W	Integer Unit 0.01S
023EH	574	The current forward reactive power demand is too high alarm threshold	4	R/W	Integer, unit Kvar 3 decimal places
0240H	576	The current forward reactive power demand is too high alarm delay	2	R/W	Integer Unit 0.01S
0241H	577	The current reverse reactive power demand is too high alarm threshold	4	R/W	Integer, unit Kvar 3 decimal places
0243H	579	The current reverse reactive power demand is too high alarm delay	2	R/W	Integer Unit 0.01S
0247H	583	Current apparent demand high alarm threshold	4	R/W	Integer, unit KVA 3 decimal places
0249H	585	Current apparent demand high alarm delay	2	R/W	Integer Unit 0.01S

## 7 Common Troubleshooting

### 7.1 The instrument RS485 networking communication failure.

Troubleshooting suggestion: Please confirm whether the RS485 wiring is loose, the AB connection is reversed, etc., and then press the button to check whether the general selection parameters in the table, such as address, baud rate, check digit, etc., are set correctly.

## **7.2 The wireless communication of the instrument is faulty.**

Troubleshooting suggestion: Please use the USB to 485 serial cable to connect to the RS485 interface of the instrument first, read the parameters in the meter through communication, and confirm whether the parameters in the meter are the same as the wireless configuration of the upper master station (channel and spreading factor), if different, please modify The wireless parameters of the meter are consistent with the master station and then re-test; if they are the same, it may be that the meter and the master station are too far away or the on-site interference is serious. At this time, you can try to use an external suction cup antenna, or consider adding a nearby wireless master station. Test again.